

# TYPE LA200V

## Afmetingen

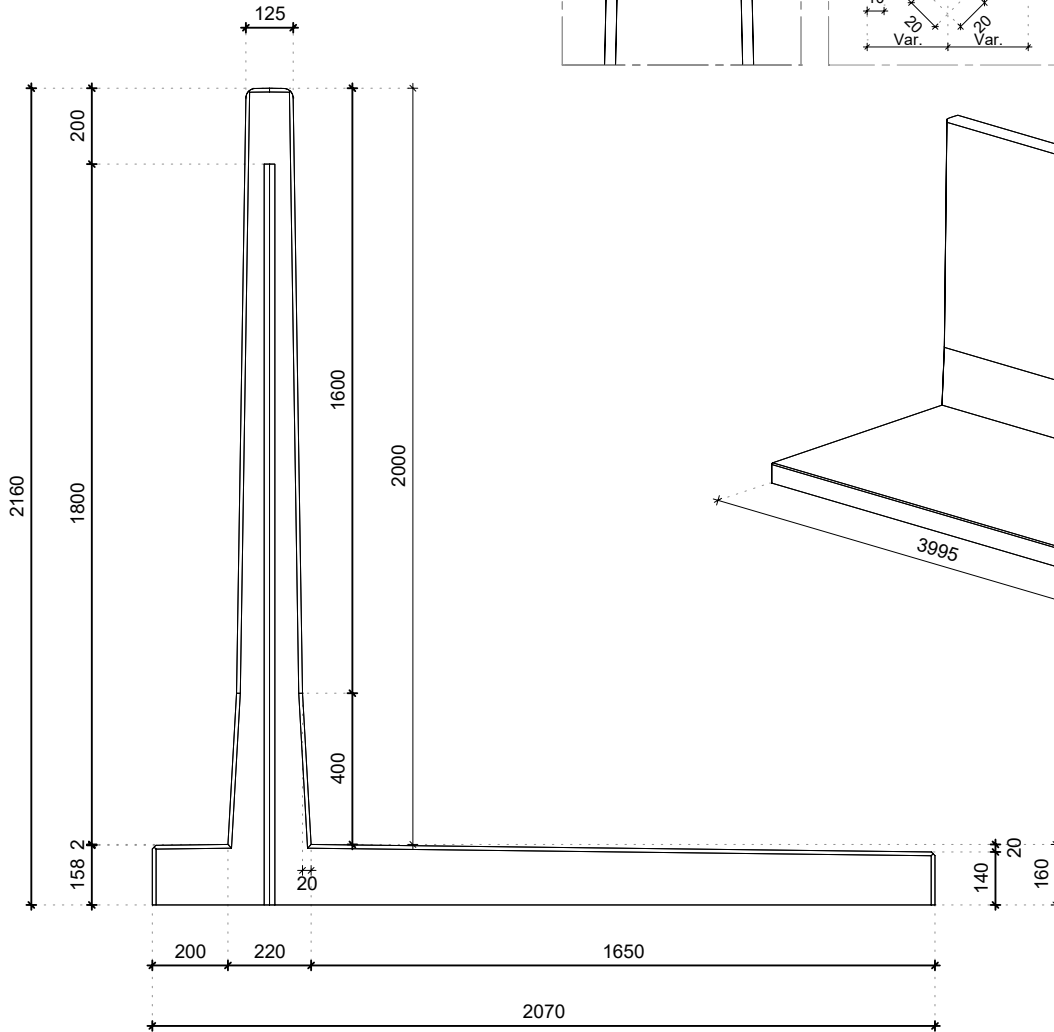

## Details

### Afgeronde bovenzijde

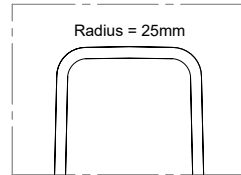

### Koppelbuis-sparing

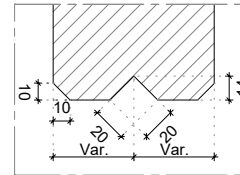

### Verbinding elementen

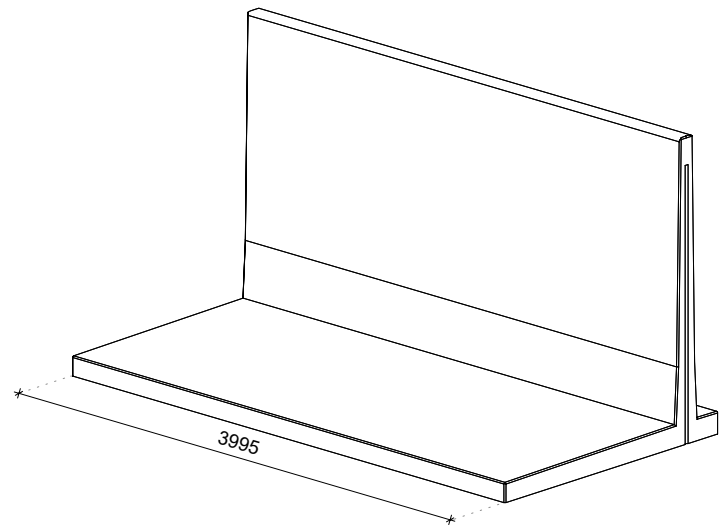
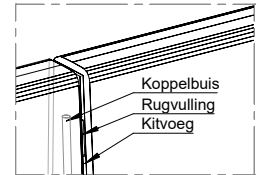

## Technische details

Betonreceptuur	2nd Generation self-compacting C60/75
Wapeningsstaal	B500
Gewicht	6010kg (L = 3995mm)
Betondekking	30mm
Maattolerantie	+/- 5mm
Zichtbetonklasse	Alle zichtzijdes klasse A (B1 op aanvraag)
Ontwerplevensduur	50 jaar
Productgarantie	20 jaar
Milieuklasse	XA3, XC4, XD3, XS3, XF4
Hijsvoorziening	Geen, plaatsen met klem

## Geconstrueerd conform

NEN-EN 1990 Eurocode 0	NEN-EN 206
NEN-EN 1991 Eurocode 1	NEN 8005
NEN-EN 1992 Eurocode 2	NEN 9997
NEN-EN 1997 Eurocode 7	Incl. nationale bijlagen

## Productiewijze



Energie  
neutraal



Gefilterd  
hemelwater



Duurzame  
grondstoffen



Recyclebare  
materialen

## Certificering

